

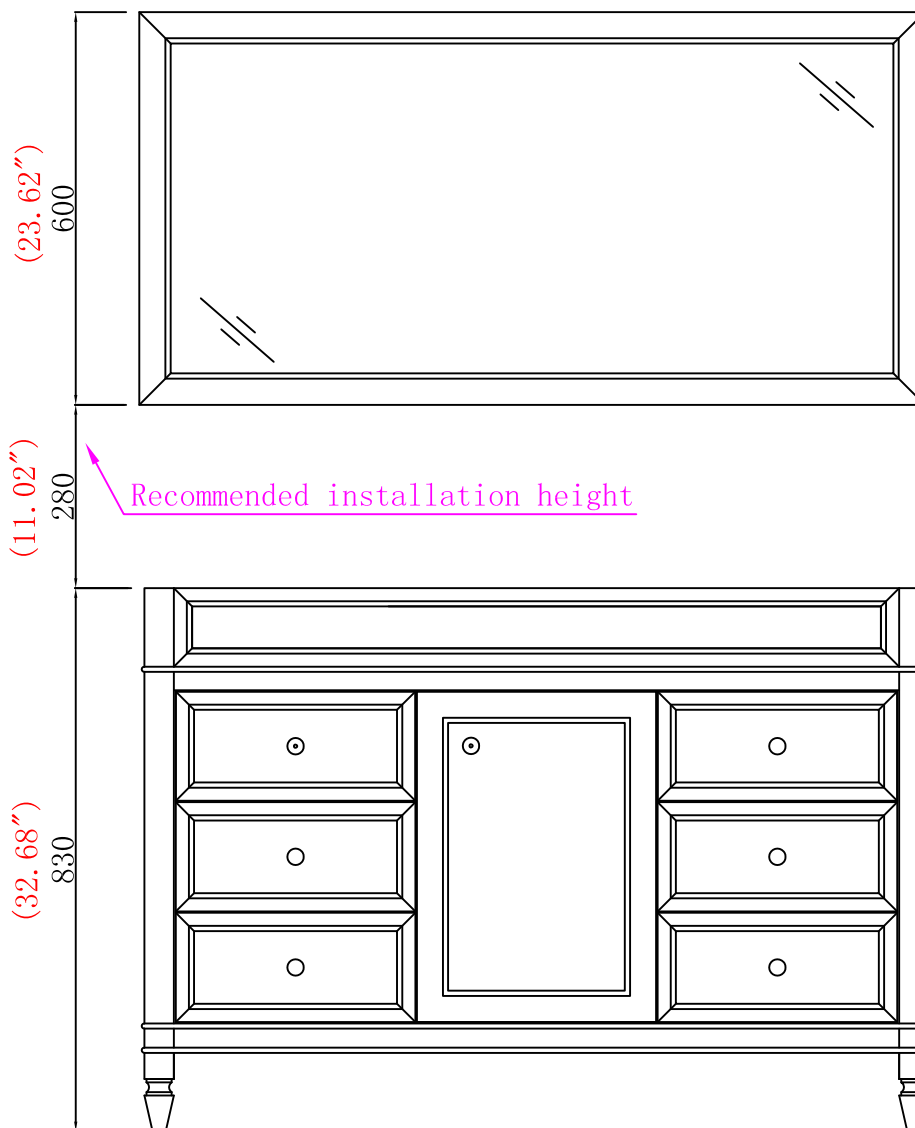





Item No. :CH48



Hardware

NO.	Draw	QTY
A		2
B		2
C		2
D		4
F	 (3.5*60)	4

FLOOR

Tools

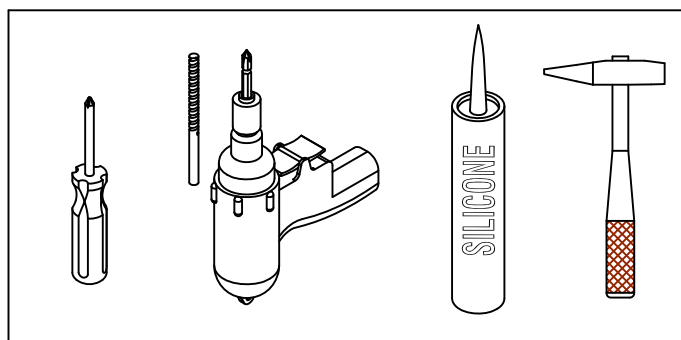

Step 1

WALL

WALL

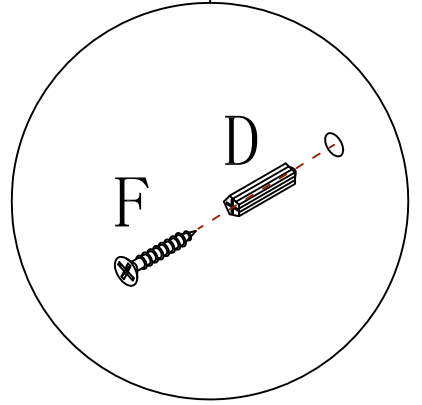
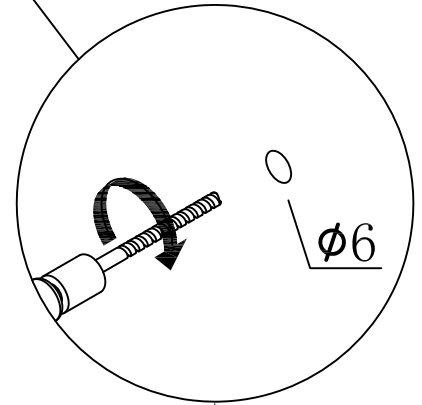
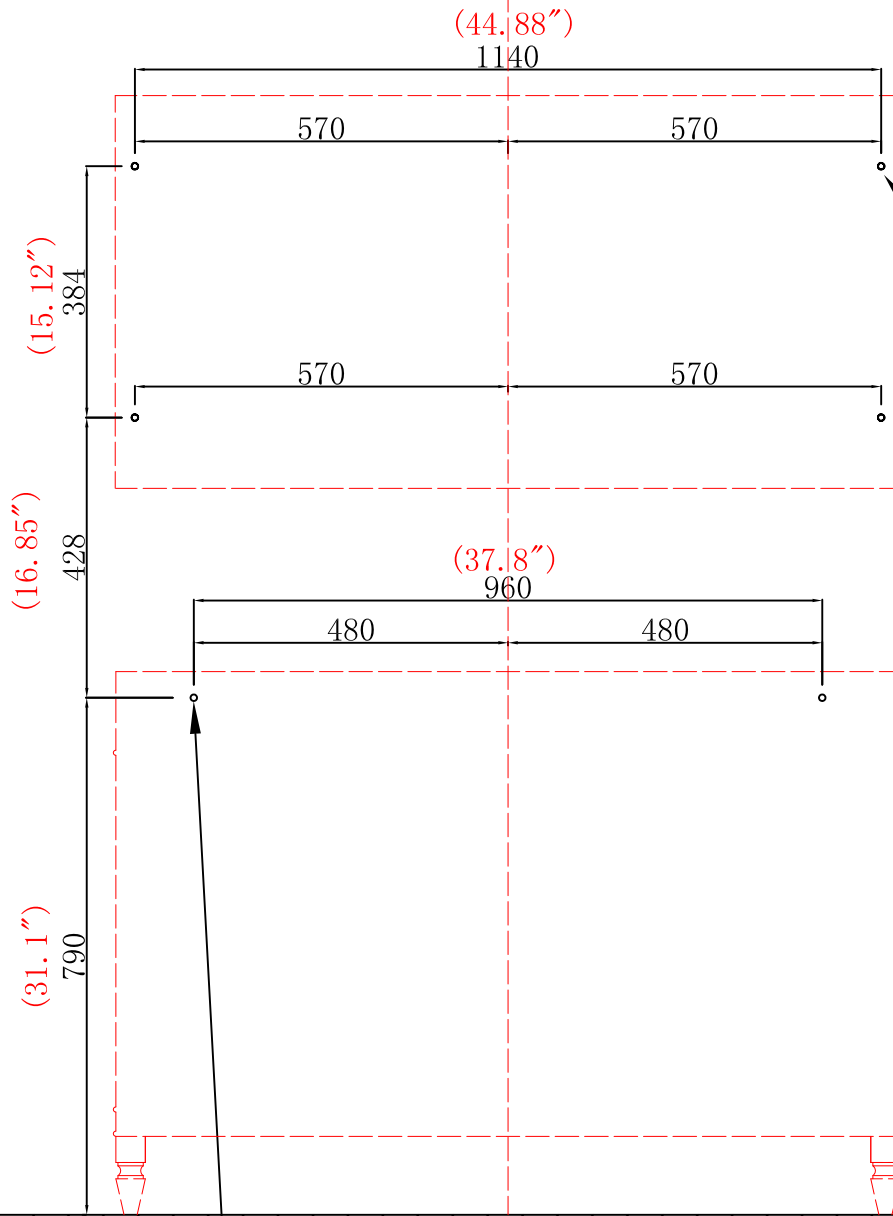

FLOOR

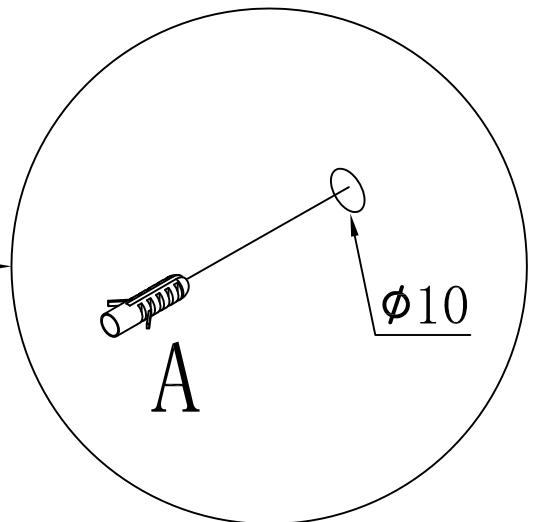
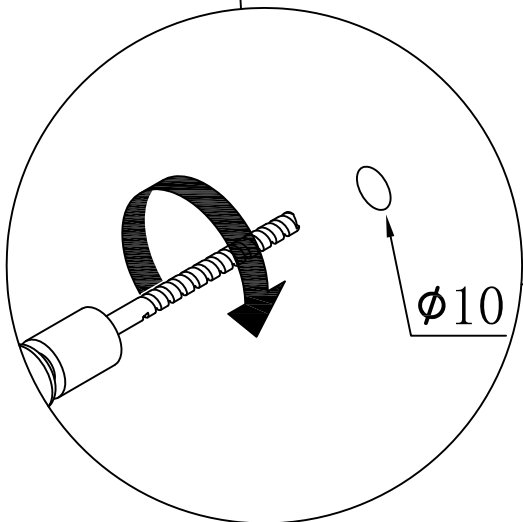

Step 2

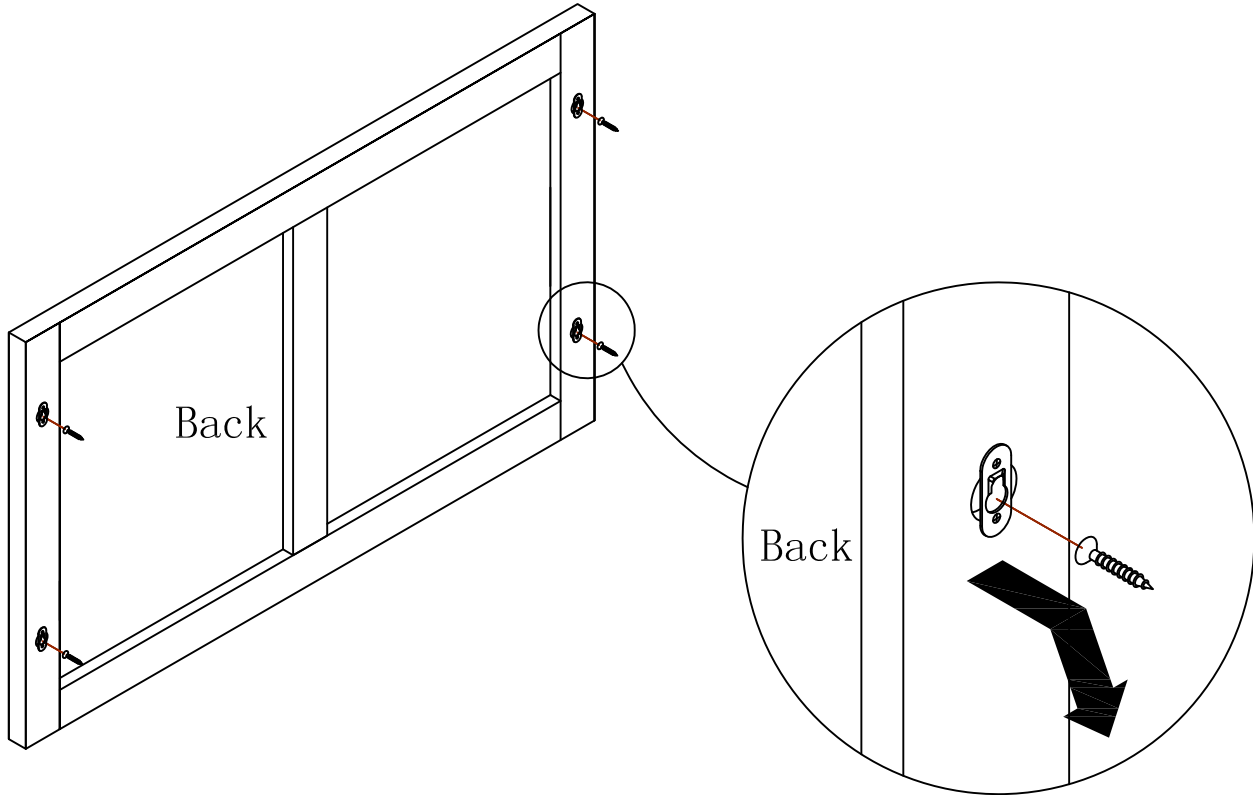

Step 3

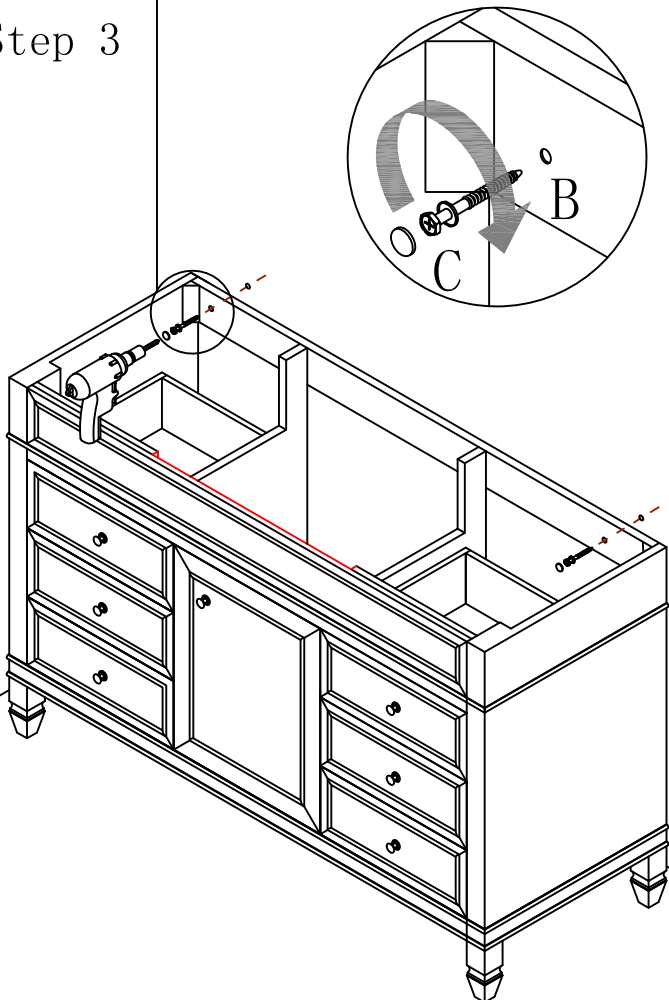

Step 4

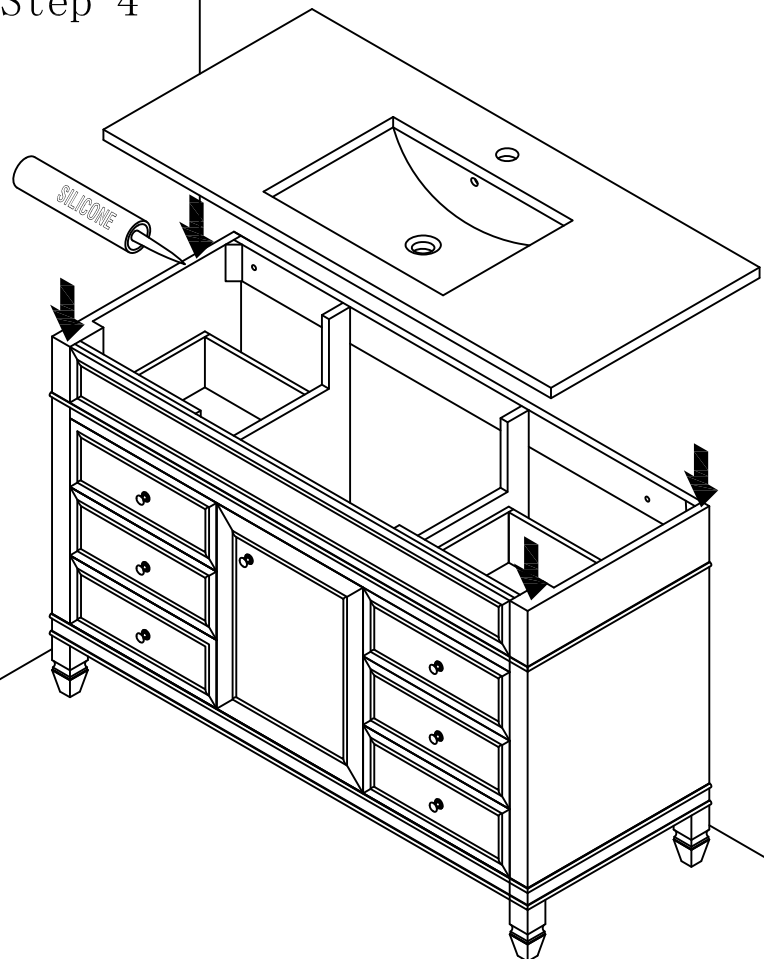

Step 5

